

LED TROFFER RETROFIT KIT 2'x4' DL SERIES



PRODUCT DESCRIPTION

LED troffer retrofit kit DL series is designed to have even illumination from end to end. It is suitable for office, hospital, and retail environments. The retrofit is a one piece and enclosed steel framed Center Basket. It is designed to upgrade fluorescent light fixtures. Assembly allows for rapid troffer conversion. Upgrade to modern full distribution architectural aesthetics providing controlled very soft, very well uniform light distribution. Easy installation and no need to remove existing fixture housing. Available in both 2x2 and 2x4 configurations.

SPECIFICATION

Length: 46.62"
 Width: 20.59"
 Height: 2.97"
 Max. Weight: 21 lbs

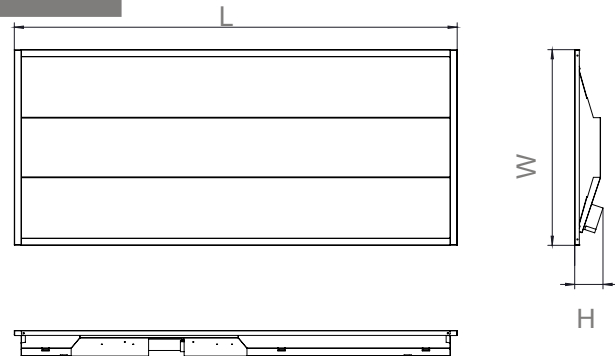

Ordering Information

Example: **TRK22D25LEDXX-DL-EBU**

TROFFER RETROFIT KIT	Dimension	Dimmable	Watts	Source type	CCT	Series	Control
TRK	24 - 2'x4'	D - 1-10V Dimmable	25 - 25 Watts ¹ 38 - 38 Watts 45 - 45 Watts	LED	30 - 3000K 35 - 3500K 40 - 4000K 50 - 5000K	Series- DL	EBU - Emergency Battery Backup

Notice:

1. All colors except 3000K for 15W is DLC Premium qualified.

* Standard Finish as White. Special Order as other finish color - Please Ask Customer Service for Details.

PERFORMANCE DATA

LUMEN OUTPUT

Lumen values are measured by third party certified laboratories performed in accordance with IESNA LM-79-08 as well as Lighting Facts listed.

Watts	Lumen Output	AC Input 120V	Measured Watts	CRI	Dist. Type	LPW
25W	3250	0.23A	25W	>80	N/A	130
38W	4560	0.35A	38W	>80	N/A	120
45W	5400	0.42A	45W	>80	N/A	120

Projected LED Lumen Maintenance

Data references the extrapolated performance projections for the LED troffer retrofit kit in a 77°F ambient, (tested per IESNA LM-80-08 and projected per IESNA TM-21-11).

Lumen Ambient Temperature (LAT) Multipliers

Use these factors to determine relative lumen output for average ambient temperature from -4-104°F (-20-40°C)

Ambient		Multiplier
Celsius	Fahrenheit	
0	32	1.02
10	50	1.01
20	68	1.00
25	77	1.00
30	86	1.00
40	104	0.99

Operating Hours	0	10,000	15,000	25,000	85,000
	Lumen Maintenance Factor	1.0	0.98(L98)	0.96(L96)	0.92(L92)

Photometry

All published luminaire photometric testing performed to IESNA LM-79-08 standards by a NVLAP certified laboratory.

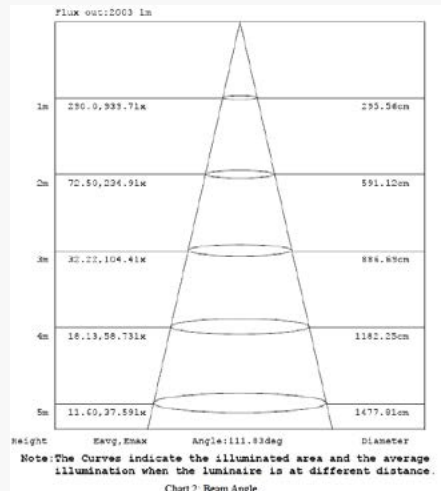
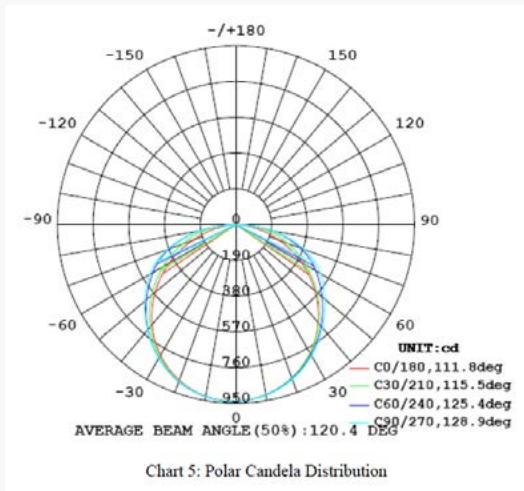

2X4 25W

PRODUCT SPECIFICATIONS

ELECTRICAL SYSTEM

- Input Voltage: 120-277V
- 50/60Hz
- 1-10V Dimmable
- Class II drivers
- Minimum Ambient -20°C, maximum 40°C
- Power Factor: > 0.98 at full load
- Total Harmonic Distortion: < 20% at full load

System Wattage	Max THD (%)	Power Factor	Power Efficiency	Replaces/ Equiv.(FL)
25W	20	>0.98	90%	2 F32T8
38W	20	>0.98	90%	3 F32T8
45W	20	>0.98	90%	4 F32T8

Ref#: 10256-10504

CERTIFICATIONS AND QUALIFICATIONS

- ETL listed
- Suitable for dry or damp locations
- DLC 3.0 Premium
- RoHS compliant

Warranty

Five year limited warranty. Full warranty terms located at www.aboveallLighting.com/warrantystatements

Note: Specifications subject to change without notice.

CASE STUDY

A company has 1,000 2x4 troffer fixtures to retro-fit. They want to know what will be the labor savings if they go with the ABOVE ALL three-piece troffer kit, vs. the “big guys” five-piece kit.

The ABOVE ALL product can be installed at the rate of seven per hour.

The Big Guys product can be installed at the rate of four per hour.

Here is the economic analysis.

ABOVE ALL

1,000 fixtures @ seven per hour = 142 man hours. At the labor rate of \$50 per hour = \$7,142 in labor cost.

“The Big Guys”

1,000 fixtures @ four per hour = 250 man hours. At the labor rate of \$50 per hour = \$12,500 in labor cost.

“The Big Guys” Labor Cost:	\$12,500
ABOVE ALL Labor Cost:	\$7,142
Total Labor Savings: \$5,358	



LED TROFFER RETROFIT KIT 2'x2' DL SERIES WITH PHILIPS LED DRIVER



PRODUCT DESCRIPTION

LED troffer retrofit kit DL series is designed to have even illumination from end to end. It is suitable for office, hospital, and retail environments. The retrofit is a one piece and enclosed steel framed Center Basket. It is designed to upgrade fluorescent light fixtures. Assembly allows for rapid troffer conversion. Upgrade to modern full distribution architectural aesthetics providing controlled very soft, very well uniform light distribution. Easy installation and no need to remove existing fixture housing. Available in both 2x2 and 2x4 configurations.

FEATURES

1. Reliable quality with PHILIPS driver.
2. High efficiency, up to 130lm/W.
3. Installation is 50% faster than any other product on the market.

SPECIFICATION

Length: 22.56"
 Width: 20.59"
 Height: 2.97"
 Max. Weight: 12 lbs

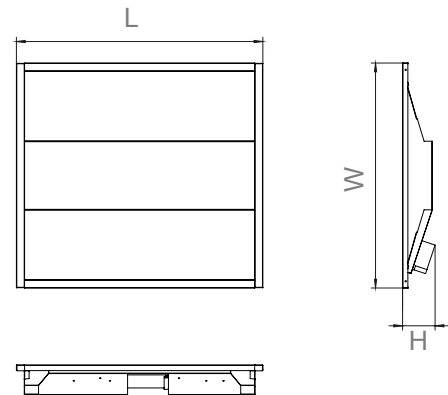

Ordering Information

Example: TRK22D25LEDXX-DL-EBU

TROFFER RETROFIT KIT	Dimension	Dimmable	Watts	Source type	CCT	Series	Control
TRK	22 - 2'x2'	D- 1-10V Dimmable	18-	LED	30 - 3000K	Series- DL	Blank-None EBU - Emergency Battery Backup
			18 Watts		35 - 3500K		
			25-		40 - 4000K		
			25 Watts		50 - 5000K		
32-							
32 Watts							

Notice:

1. All colors for 18W is DLC Standard qualified.
2. All colors except 3000K for 25W is DLC Premium qualified.
3. For EBU solution, 18W is excluded.

* Standard Finish as White. Special Order as other finish color - Please Ask Customer Service for Details.

PERFORMANCE DATA

LUMEN OUTPUT

Lumen values are measured by third party certified laboratories performed in accordance with IESNA LM-79-08 as well as Lighting Facts listed.

Watts	Lumen Output	AC Input 120V	Measured Watts	CRI	Dist. Type	LPW
18W	2160	0.17A	18W	>80	N/A	120
25W	3250	0.23A	25W	>80	N/A	130
32W	3840	0.29A	32W	>80	N/A	120

Projected LED Lumen Maintenance

Data references the extrapolated performance projections for the LED troffer retrofit kit in a 77°F ambient, (tested per IESNA LM-80-08 and projected per IESNA TM-21-11).

Lumen Ambient Temperature (LAT) Multipliers

Use these factors to determine relative lumen output for average ambient temperature from -4-104°F (-20-40°C)

Ambient		Multiplier
Celsius	Fahrenheit	
0	32	1.02
10	50	1.01
20	68	1.00
25	77	1.00
30	86	1.00
40	104	0.99

Operating Hours	0	10,000	15,000	25,000	85,000
	Lumen Maintenance Factor	1.0	0.98(L98)	0.96(L96)	0.92(L92)

Photometry

All published luminaire photometric testing performed to IESNA LM-79-08 standards by a NVLAP certified laboratory.

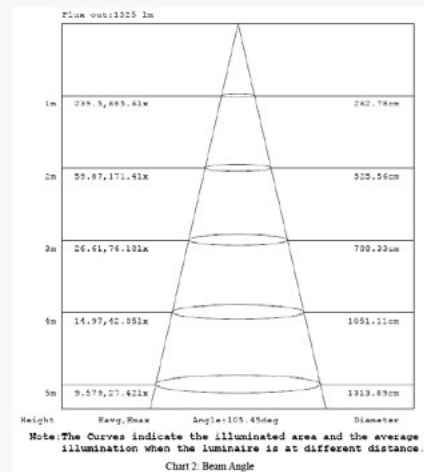
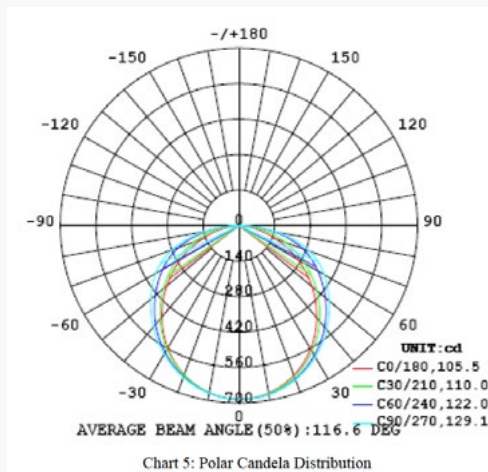

2X2 18W

PRODUCT SPECIFICATIONS

ELECTRICAL SYSTEM

- Input Voltage: 120-277V
- 50/60Hz
- 1-10V Dimmable
- Class II drivers
- Minimum Ambient -20°C, maximum 40°C
- Power Factor: > 0.98 at full load
Total Harmonic Distortion: < 20% at full load

System Wattage	Max THD (%)	Power Factor	Power Efficiency	Replaces/ Equiv.(FL)
18W	20	>0.98	90%	2 F17T8
25W	20	>0.98	90%	3 F17T8
32W	20	>0.98	90%	4 F17T8

Ref#: 10264-10712

CERTIFICATIONS AND QUALIFICATIONS

- ETL listed
- Suitable for dry or damp locations
- DLC 3.0 Premium
- RoHS compliant

Warranty

Seven year limited warranty. Full warranty terms located at www.aboveallLighting.com/warrantystatements
 Any failed fixture will be replaced under the warranty agreement.

Note: Specifications subject to change without notice.

LED TROFFER RETROFIT KIT 2'x4' DL SERIES WITH PHILIPS LED DRIVER



PRODUCT DESCRIPTION

LED troffer retrofit kit DL series is designed to have even illumination from end to end. It is suitable for office, hospital, and retail environments. The retrofit is a one piece and enclosed steel framed Center Basket. It is designed to upgrade fluorescent light fixtures. Assembly allows for rapid troffer conversion. Upgrade to modern full distribution architectural aesthetics providing controlled very soft, very well uniform light distribution. Easy installation and no need to remove existing fixture housing. Available in both 2x2 and 2x4 configurations.

FEATURES

1. Reliable quality with PHILIPS driver.
2. High efficiency, up to 130lm/W.
3. Installation is 50% faster than any other product on the market.

SPECIFICATION

Length: 46.62"
 Width: 20.59"
 Height: 2.97"
 Max. Weight: 21 lbs

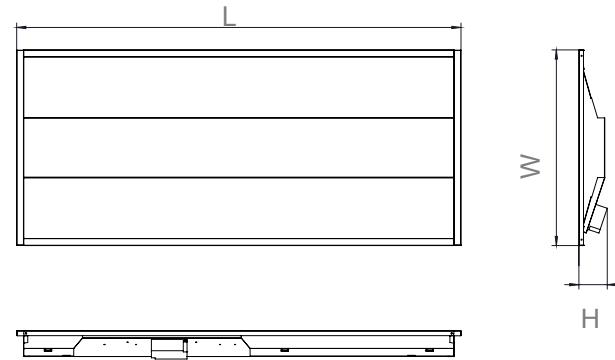

Ordering Information

Example: **TRK22D25LEDXX-DL-EBU**

TROFFER RETROFIT KIT	Dimension	Dimmable	Watts	Source type	CCT	Series	Control
TRK	24 - 2'x4'	D - 1-10V Dimmable	25 - 25 Watts ¹ 38 - 38 Watts 45 - 45 Watts	LED	30 - 3000K 35 - 3500K 40 - 4000K 50 - 5000K	Series- DL	Blank-None EBU - Emergency Battery Backup

Notice:

1. All colors except 3000K for 25W is DLC Premium qualified.
- * Standard Finish as White. Special Order as other finish color - Please Ask Customer Service for Details.

Talk to one of our LED consultants today! info@sitlersupplies.com
 (800) 426-3938 • (319) 653 3198 www.sitlersledsupplies.com

PERFORMANCE DATA

LUMEN OUTPUT

Lumen values are measured by third party certified laboratories performed in accordance with IESNA LM-79-08 as well as Lighting Facts listed.

Watts	Lumen Output	AC Input 120V	Measured Watts	CRI	Dist. Type	LPW
25W	3250	0.23A	25W	>80	N/A	130
38W	4560	0.35A	38W	>80	N/A	120
45W	5400	0.42A	45W	>80	N/A	120

Projected LED Lumen Maintenance

Data references the extrapolated performance projections for the LED troffer retrofit kit in a 77°F ambient, (tested per IESNA LM-80-08 and projected per IESNA TM-21-11).

Lumen Ambient Temperature (LAT) Multipliers

Use these factors to determine relative lumen output for average ambient temperature from -4-104°F (-20-40°C)

Ambient		Multiplier
Celsius	Fahrenheit	
0	32	1.02
10	50	1.01
20	68	1.00
25	77	1.00
30	86	1.00
40	104	0.99

Operating Hours	0	10,000	15,000	25,000	85,000
	Lumen Maintenance Factor	1.0	0.98(L98)	0.96(L96)	0.92(L92)

Photometry

All published luminaire photometric testing performed to IESNA LM-79-08 standards by a NVLAP certified laboratory.

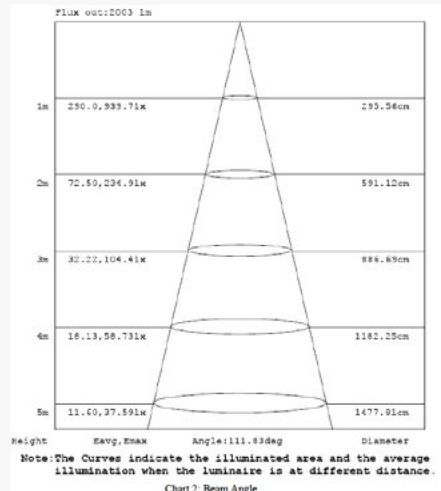
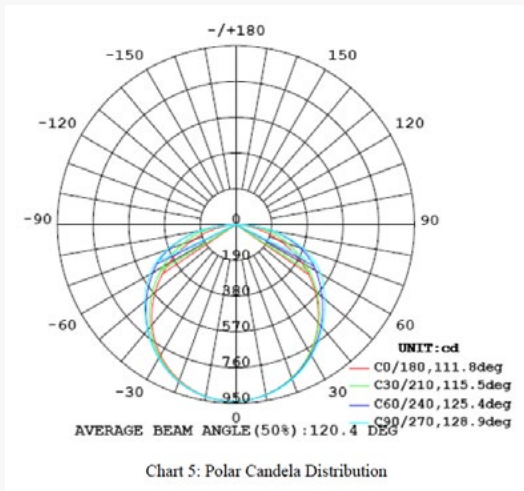

2X4 25W

PRODUCT SPECIFICATIONS

ELECTRICAL SYSTEM

- Input Voltage: 120-277V
- 50/60Hz
- 1-10V Dimmable
- Class II drivers
- Minimum Ambient -20°C, maximum 40°C
- Power Factor: > 0.98 at full load
- Total Harmonic Distortion: < 20% at full load

System Wattage	Max THD (%)	Power Factor	Power Efficiency	Replaces/ Equiv.(FL)
25W	20	>0.98	90%	2 F32T8
38W	20	>0.98	90%	3 F32T8
45W	20	>0.98	90%	4 F32T8

Ref#: 10256-10712

CERTIFICATIONS AND QUALIFICATIONS

- ETL listed
- Suitable for dry or damp locations
- DLC 3.0 Premium
- RoHS compliant

Warranty

Seven year limited warranty. Full warranty terms located at www.aboveallLighting.com/warrantystatements
 Any failed fixture will be replaced under the warranty agreement.

Note: Specifications subject to change without notice.